

# ELEIKO IWF WEIGHTLIFTING COMPETITION PLATFORM - OAK BEAMS

Art.nr 3060795-01

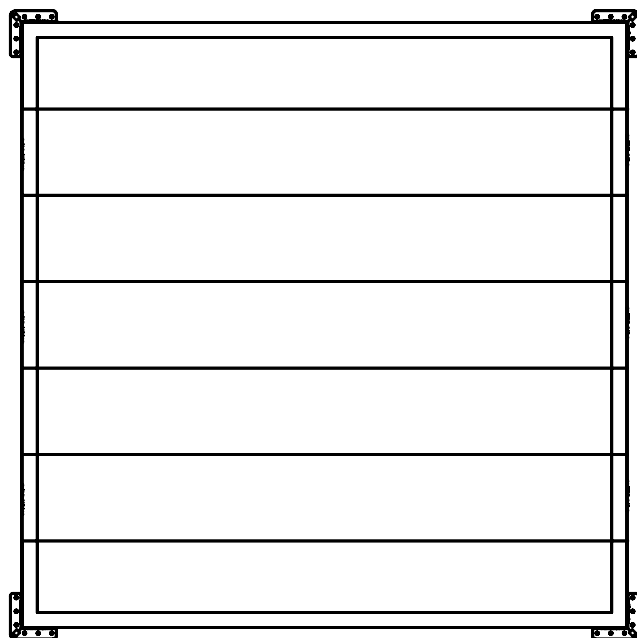



# READ BEFORE INSTALLATION AND USE

## CAUTION

The equipment must be installed and used in a place whose access and supervision are specifically controlled by the owner.

Be sure to install the equipment on a stable podium and properly level the equipment. **Cant be to flat and levelled, slightly inclined podium, the bar will roll of the platform.** ELEIKO recommends that all equipment is secured to floor and installed by a licensed contractor or an ELEIKO-installer.

## SAFETY INSTRUCTIONS

It is the responsibility of the purchaser of ELEIKO products to instruct all users and supervising personnel on proper usage of the equipment.

1. All included warnings (labels) and instructions **MUST** be read before the use of any ELEIKO-equipment. Use each equipment as it is intended for.
2. A user **MUST** get a medical examination and proper instructions before the use of any ELEIKO-equipment.
3. **DO NOT** let anyone, under any circumstances, use equipment that appears to be damaged. Do not try to repair any equipment before consulting an ELEIKO technician.
4. **DO NOT** replace the components of ELEIKO-equipment with other none ELEIKO-equipment (magnetic safety pin, frames, bars), do not improvise. If there are any doubts consult an ELEIKO representative prior to any intervention.
5. **DO NOT** overload the equipment and **DO NOT** try to exceed personal strength levels.
6. Children under the age of 14 must be supervised by an adult.
7. **DO NOT** remove any safety labels from the ELEIKO-equipment. ELEIKO is not responsible if a label is removed. Replace damaged labels immediately.

## PREVENTITIVE MAINTENANCE & INSPECTIONS

DAILY:

Cleaning of surface: sweep the surface.

REGULARLY:

Clean the surfaces on frames from dust and dirt.

Check that all bolts between parts, walls, floors are properly tightened, according to recommendations. Use mild detergent (no silicone) to clean the surface.

## WARRANTY

All products manufactured by ELEIKO are warranted to the original purchaser to be free from defects in workmanship and / or materials under normal use or service as follows:

5 years

Normal wear and tear does not fall under the warranty.

## ADDITIONAL INFORMATION

This equipment is for indoor use only.

**ELEIKO**

# PRODUCT SPECIFICATIONS

Weightlifting competition platform. For indoor use only.

Product weight	1180 kg
Dimensions (L x W x H)	4000x4000x100 mm

## FOOTPRINT AREA

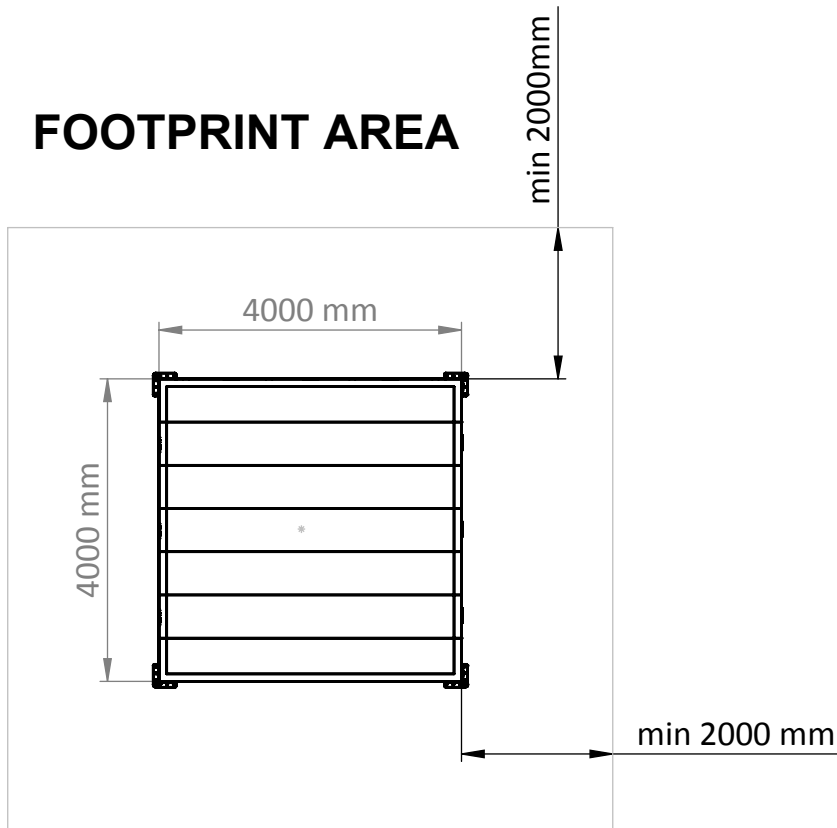

Add sufficient clearance, not less than 2 m, on all sides.

# CONTENTS

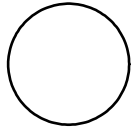

x8  
Grey sticker



x8  
Nut M16

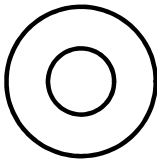

x8  
Washer

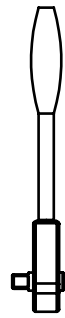

Wrench 1/2

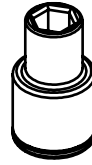

Socket 1/2-24



Socket 1/2-17



Screwdriver flat  
min 1,6x10



Sledge hammer,  
plastic

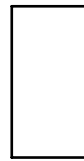

Wooden piece

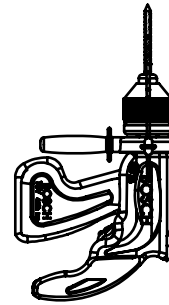

Drill machine  
(Not included)



Drill bit 6 mm



Spirit level

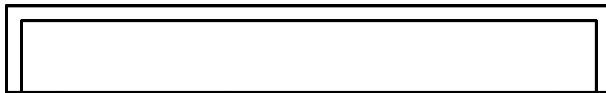

x1  
Beam

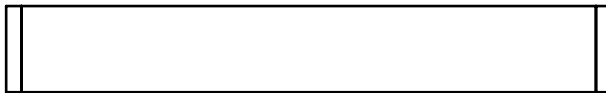

x5  
Beam

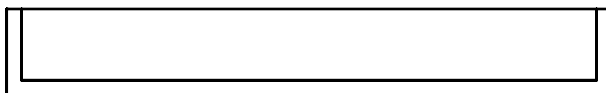

x1  
Beam



x4  
Steel rod

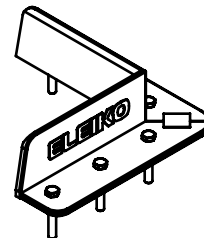

x4  
Corner

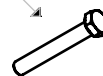

x24  
Screws, wooden

# ASSEMBLY INSTRUCTIONS

1.

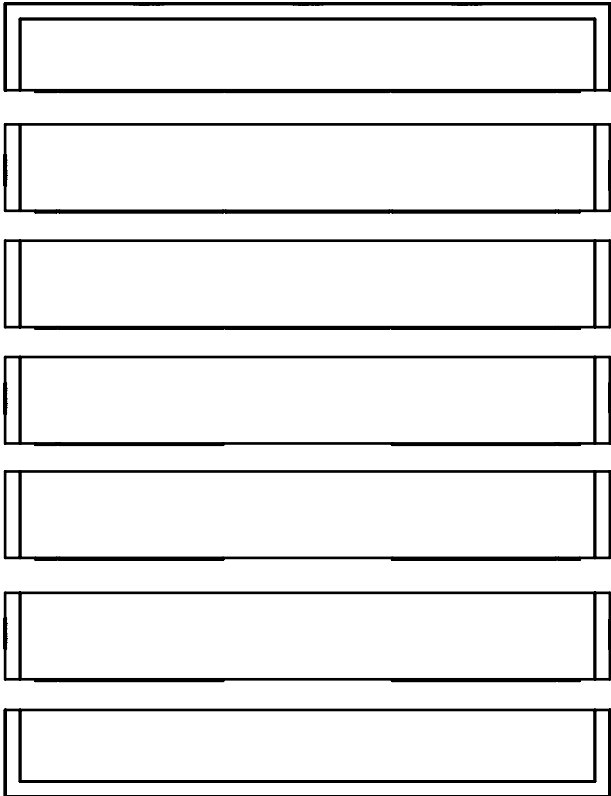

Beam



Wooden piece



Sledge hammer,  
plastic



2

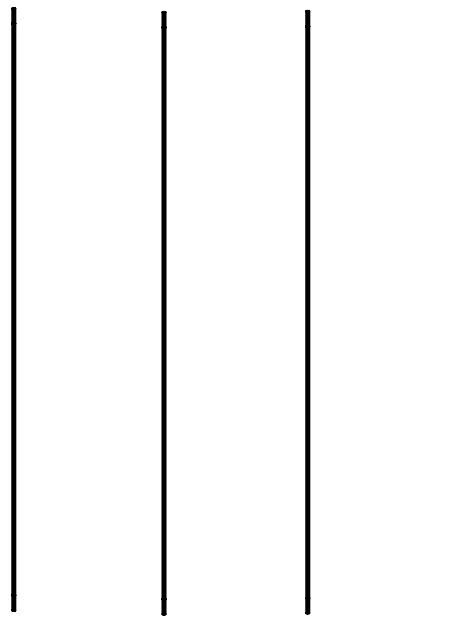
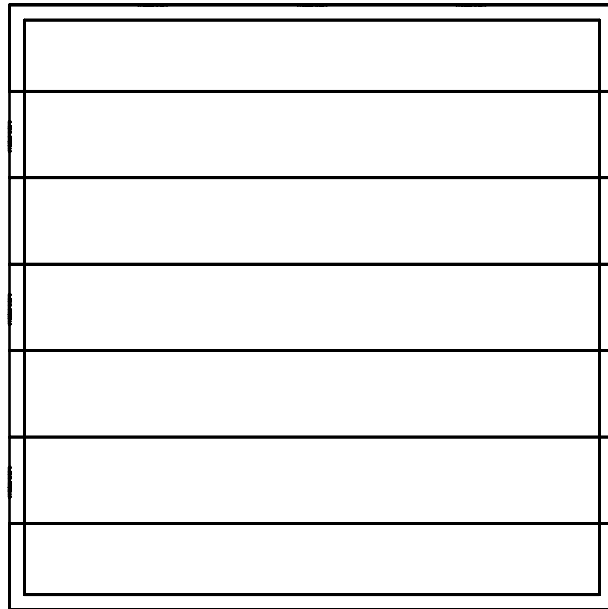

Steel rod



3

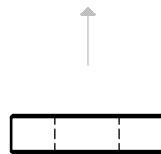
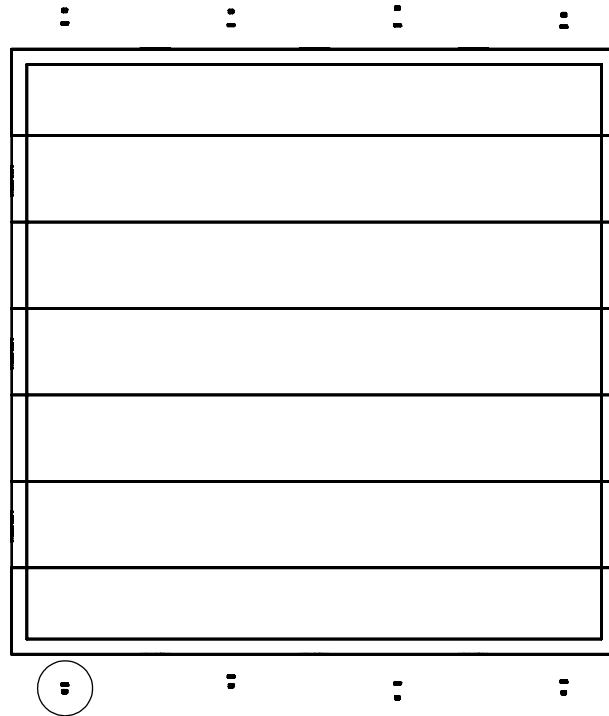
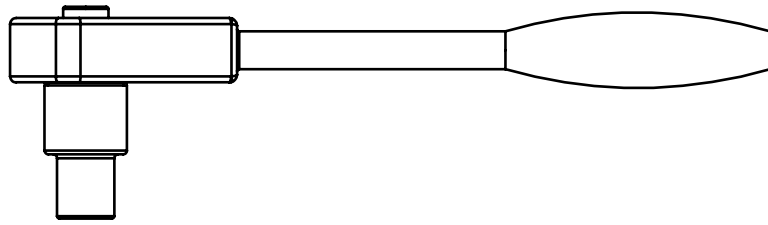

Washer

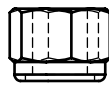

Nut M16

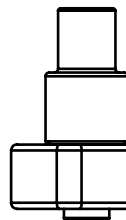

Socket 1/2-24

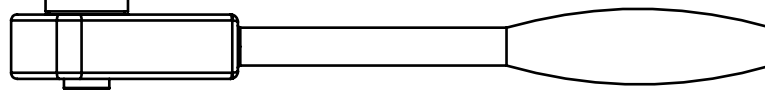

Wrench 1/2

Tighten torque 210 Nm



4

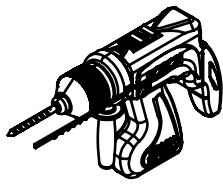

Drill machine



6 mm

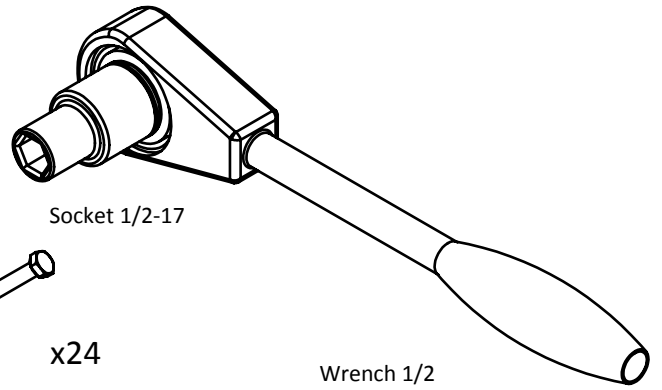

Socket 1/2-17

Wrench 1/2



x24

Screws, wooden

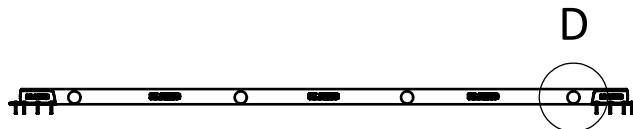
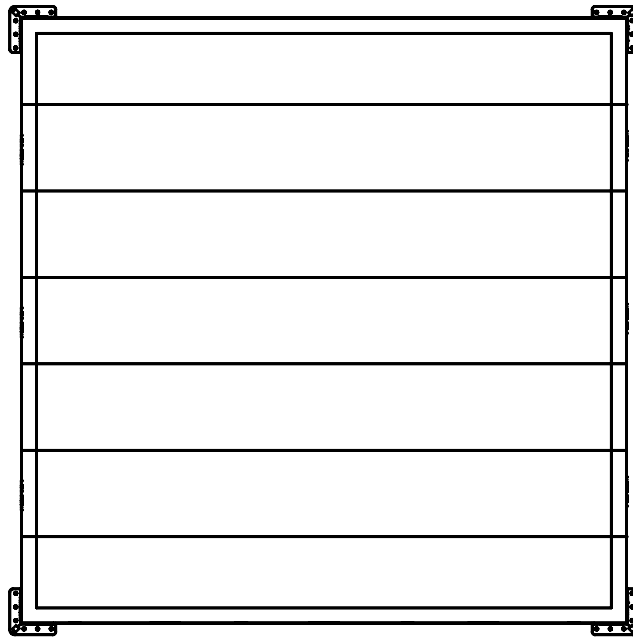

D



Grey sticker

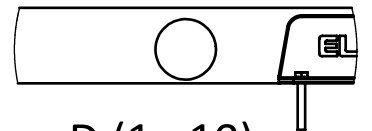

D (1 : 10)







Eleiko Group AB | Klastorpsvägen 18 | SE-302 62 HALMSTAD | Sweden  
E-mail: [info@eleiko.com](mailto:info@eleiko.com) | Phone: +46 35 17 70 70

[www.eleiko.com](http://www.eleiko.com)